

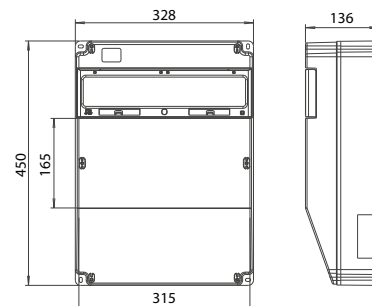













Rozvodnice ROS 16 IP54 a IP66

- ROS 16/FI - Standard = rozvodnice sú kompletne osadené potrebnými istiacimi a ochrannými prvkami.
- ROS 16/I - Economic = základný počet istiacich prvkov.
- ROS 16/x - Neistená = bez istiacich prvkov, kabeláž v rozvodnici je pripravená pre osadenie istiacimi a ochrannými prvkami podľa verzie Standard.
- Určené na montáž na stenu ako súčasť pevného rozvodu.
- Kryt odolný proti nadmernému teplu a horeniu (650 °C).
- Predlisované sústredené otvory pre vývodky zhora aj zdola: 2x (M32; M40), 1x (M25; M32; M40; M50); zozadu 1x (23,5 až 52,5 mm).
- Dodaná vývodka M 40 v kombináciach bez prívodky.
- Max. prívod kábla: tuhý vodič 5 x 25 mm².
- Rozmery 450 x 328 x 136 mm (V x Š x H).



Vyhovuje normám:	STN EN 61439-1, STN EN 61439-3
Mechanická odolnosť krabice:	IK10
Materiál:	ABS
Menovité pracovné napätie:	400 V~, 250 V~, 50/60 Hz
Prevádzková teplota:	-25 °C až +40 °C

203080

Obj. č. (Typ)	Osadenie	CEE 400 V 5P			250 V		Hlavný vypínač	Prúd. chrániče RCCB	Ističe MCB			Pripojenie	Krytie	InA	RDF	Bal. (ks)
		63 A	32 A	16 A	16 A Fr	16 A Sch			63 A	63 A/4/0,03 A	32 A 3P-C					
203000 (ROS 16/FI-103)					4	-										
203001 (ROS 16/FI-103/S)					-	4		1	1	1	4	5 x 25 mm ² r 5 x 16 mm ² M40	IP54	InA 63 A	0,6	1
203002 (ROS 16/I-103)		-	1	1	4	-		-	1	1	2				1,0	
203003 (ROS 16/I-103/S)					4	-									0,6	
203004 (ROS 16/x-103)					-	4										
203005 (ROS 16/x-103/S)					-	4										
203006 (ROS 16/FI-104)					6	-										
203007 (ROS 16/FI-104/S)					-	6		1	1	1	6	5 x 25 mm ² r 5 x 16 mm ² M40	IP54	InA 63 A	0,6	1
203008 (ROS 16/I-104)		-	1	1	6	-		-	1	1	3				1,0	
203009 (ROS 16/I-104/S)					-	6									0,6	
203010 (ROS 16/x-104)					6	-										
203011 (ROS 16/x-104/S)					-	6										
203012 (ROS 16/FI-108)					12	-										
203013 (ROS 16/FI-108/S)					-	12		1	1	1	6	5 x 25 mm ² r 5 x 16 mm ² M40	IP54	InA 63 A	0,6	1
203014 (ROS 16/I-108)		-	1	1	12	-		-	1	1	4				0,8	
203015 (ROS 16/I-108/S)					-	12									0,6	
203016 (ROS 16/x-108)					12	-										
203017 (ROS 16/x-108/S)					-	12										
203018 (ROS 16/FI-111)					4	-										
203019 (ROS 16/FI-111/S)					-	4		1	1	2	2	5 x 25 mm ² r 5 x 16 mm ² M40	IP54	InA 63 A	0,6	1
203020 (ROS 16/I-111)		-	1	2	4	-		-	1	1	2				1,0	
203021 (ROS 16/I-111/S)					-	4									0,6	
203022 (ROS 16/x-111)					4	-										
203023 (ROS 16/x-111/S)					-	4										
203024 (ROS 16/FI-112)					6	-										
203025 (ROS 16/FI-112/S)					-	6		1	1	2	3	5 x 25 mm ² r 5 x 16 mm ² M40	IP54	InA 63 A	0,6	1
203026 (ROS 16/I-112)		-	1	2	6	-		-	1	1	3				1,0	
203027 (ROS 16/I-112/S)					-	6									0,6	
203028 (ROS 16/x-112)					6	-										
203029 (ROS 16/x-112/S)					-	6										
203030 (ROS 16/FI-117)					4	-										
203031 (ROS 16/FI-117/S)					-	4		1	2	1	2	5 x 25 mm ² r 5 x 16 mm ² M40	IP54	InA 63 A	0,5	1
203032 (ROS 16/I-117)		-	2	1	4	-		-	1	1	2				1,0	
203033 (ROS 16/I-117/S)					-	4									0,5	
203034 (ROS 16/x-117)					4	-										
203035 (ROS 16/x-117/S)					-	4										
203036 (ROS 16/FI-123)					4	-										
203037 (ROS 16/FI-123/S)					-	4		1	1	2	2	5 x 25 mm ² r 5 x 16 mm ² M40	IP54	InA 63 A	0,6	1
203038 (ROS 16/I-123)		-	2	2	4	-		-	1	1	2				1,0	
203039 (ROS 16/I-123/S)					-	4									0,6	
203040 (ROS 16/x-123)					4	-										
203041 (ROS 16/x-123/S)					-	4										





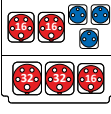
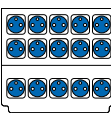

RDF - Menovitý súčiniteľ súdobnosti, InA - Menovitý prúd zostavy

Rozvodnice ROS 16 IP54 a IP66 (pokračovanie)

Obj. č. (Typ)	Osadenie	CEE 400 V 5P			250 V		Hlavný vypínač 63 A	Prúdové chrániče RCCB 63 A/4/0,03 A	Ističe MCB			Pripojenie	Krytie	InA	RDF	Bal. (ks)
		63 A	32 A	16 A	16 A Fr	16 A Sch			32 A 3P-C	16 A 3P-C	16 A 1P-B					
203042 (ROS 16/FI-128)					3	-		1	1	2	3	5 x 25 mm ² r 5 x 16 mm ² M40	IP54	InA 63 A	1,0	1
203043 (ROS 16/FI-128/S)					-	3										
203044 (ROS 16/I-128)					3	-										
203045 (ROS 16/I-128/S)					-	3										
203046 (ROS 16/x-128)					3	-										
203047 (ROS 16/x-128/S)				-	3											
203048 (ROS 16/FI-134)					15	-		1	-	-	10	5 x 25 mm ² r 5 x 16 mm ² M40	IP54	InA 63 A	1,0	1
203049 (ROS 16/FI-134/S)					-	15										
203050 (ROS 16/I-134)					15	-										
203051 (ROS 16/I-134/S)					-	15										
203052 (ROS 16/x-134)					15	-										
203053 (ROS 16/x-134/S)				-	15											

RDF - Menovitý súčiniteľ súdobosti, InA - Menovitý prúd zostavy

so 63 A zásuvkou

Obj. č. (Typ)	Osadenie	CEE 400 V 5P			250 V		Hlavný vypínač 63 A	Prúdové chrániče RCCB 63 A/4/0,03 A	Ističe MCB			Pripojenie	Krytie	InA	RDF	Bal. (ks)
		63 A	32 A	16 A	16 A Fr	16 A Sch			32 A 3P-C	16 A 3P-C	16 A 1P-B					
203070 (ROS 16/FI-203)					4	-		1	1	1	4	5 x 25 mm ² r 5 x 16 mm ² M40	IP54	InA 63 A	0,5	1
203071 (ROS 16/FI-203/S)					-	4										
203072 (ROS 16/I-203)					4	-										
203073 (ROS 16/I-203/S)					-	4										
203074 (ROS 16/x-203)					4	-										
203075 (ROS 16/x-203/S)				-	4											
203076 (ROS 16/FI-206)					10	-		1	1	1	5	5 x 25 mm ² r 5 x 16 mm ² M40	IP54	InA 63 A	0,5	1
203077 (ROS 16/FI-206/S)					-	10										
203078 (ROS 16/I-206)					10	-										
203079 (ROS 16/I-206/S)					-	10										
203080 (ROS 16/x-206)					10	-										
203081 (ROS 16/x-206/S)				-	10											
203082 (ROS 16/FI-209)					4	-		1	1	2	2	5 x 25 mm ² r 5 x 16 mm ² M40	IP54	InA 63 A	0,5	1
203083 (ROS 16/FI-209/S)					-	4										
203084 (ROS 16/I-209)					4	-										
203085 (ROS 16/I-209/S)					-	4										
203086 (ROS 16/x-209)					4	-										
203087 (ROS 16/x-209/S)				-	4											
203088 (ROS 16/FI-215)					4	-		1	2	1	2	5 x 25 mm ² r 5 x 16 mm ² M40	IP54	InA 63 A	0,5	1
203089 (ROS 16/FI-215/S)					-	4										
203090 (ROS 16/I-215)					4	-										
203091 (ROS 16/I-215/S)					-	4										
203092 (ROS 16/x-215)					4	-										
203093 (ROS 16/x-215/S)				-	4											
203094 (ROS 16/FI-221)					4	-		1	1	2	2	5 x 25 mm ² r 5 x 16 mm ² M40	IP54	InA 63 A	0,5	1
203095 (ROS 16/FI-221/S)					-	4										
203096 (ROS 16/I-221)					4	-										
203097 (ROS 16/I-221/S)					-	4										
203098 (ROS 16/x-221)					4	-										
203099 (ROS 16/x-221/S)				-	4											
203100 (ROS 16/FI-225)					3	-		1	1	2	3	5 x 25 mm ² r 5 x 16 mm ² M40	IP54	InA 63 A	0,5	1
203101 (ROS 16/FI-225/S)					-	3										
203102 (ROS 16/I-225)					3	-										
203103 (ROS 16/I-225/S)					-	3										
203104 (ROS 16/x-225)					3	-										
203105 (ROS 16/x-225/S)				-	3											

RDF - Menovitý súčiniteľ súdobosti, InA - Menovitý prúd zostavy



Rozvodnice ROS 16 IP54 a IP66 (pokračovanie)
so 63 A prívodkou

Obj. č. (Typ)	Osadenie	CEE 400 V 5P			250 V		Hlavný vypínač 63 A	Prúdové chrániče RCCB 63 A/4/0,03 A	Ističe MCB			Pripojenie	Krytie	InA	RDF	Bal. (ks)	
		63 A	32 A	16 A	16 A Fr	16 A Sch			32 A 3P-C	16 A 3P-C	16 A 1P-B						
203130 (ROS 16/FI-304)					6	-	-	1	1	1	6	CEE prívodka 63 A/5P/400 V	IP54	InA 63 A	1,0	1	
203131 (ROS 16/FI-304/S)					-	6											
203132 (ROS 16/I-304)					6	-											
203133 (ROS 16/I-304/S)			1	1	1	-											6
203134 (ROS 16/x-304)						6											-
203135 (ROS 16/x-304/S)						-											6

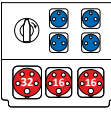
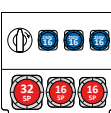

RDF - Menovitý súčiniteľ súdobosti, InA - Menovitý prúd zostavy

so 63 A vypínačom

Obj. č. (Typ)	Osadenie	CEE 400 V 5P			250 V		Hlavný vypínač 63 A	Prúdové chrániče RCCB 63 A/4/0,03 A	Ističe MCB			Pripojenie	Krytie	InA	RDF	Bal. (ks)
		63 A	32 A	16 A	16 A Fr	16 A Sch			32 A 3P-C	16 A 3P-C	16 A 1P-B					
203150 (ROS 16/FI-412)					4	-	1	1	2	2	5 x 25 mm ² r 5 x 16 mm ² M40	IP54	InA 63 A	1,0	1	
203151 (ROS 16/FI-412/S)					-	4										
203152 (ROS 16/I-412)					4	-										
203153 (ROS 16/I-412/S)			1	2		-										4
203154 (ROS 16/x-412)						4										-
203155 (ROS 16/x-412/S)						-										4
203156 (ROSG 16/FI-411)					3	-	1	1	2	2	5 x 25 mm ² r 5 x 16 mm ² M40	IP66	InA 63 A	1,0	1	
203157 (ROSG 16/FI-411/S)					-	3										
203158 (ROSG 16/I-411)					3	-										
203159 (ROSG 16/I-411/S)			1	2		-										3
203160 (ROSG 16/x-411)						3										-
203161 (ROSG 16/x-411/S)						-										3

RDF - Menovitý súčiniteľ súdobosti, InA - Menovitý prúd zostavy

so 63 A vypínačom a prívodkou

Obj. č. (Typ)	Osadenie	CEE 400 V 5P			250 V		Hlavný vypínač 63 A	Prúdové chrániče RCCB 63 A/4/0,03 A	Ističe MCB			Pripojenie	Krytie	InA	RDF	Bal. (ks)
		63 A	32 A	16 A	16 A Fr	16 A Sch			32 A 3P-C	16 A 3P-C	16 A 1P-B					
203180 (ROS 16/FI-516)					4	-	1	1	2	2	CEE prívodka 63 A/5P/400 V	IP54	InA 63 A	1,0	1	
203181 (ROS 16/FI-516/S)					-	4										
203182 (ROS 16/I-516)					4	-										
203183 (ROS 16/I-516/S)			2	2		-										4
203184 (ROS 16/x-516)						4										-
203185 (ROS 16/x-516/S)						-										4
203186 (ROSG 16/FI-506)					2	-	1	1	2	2	CEE prívodka 63 A/5P/400 V	IP66	InA 63 A	1,0	1	
203187 (ROSG 16/FI-506/S)					-	2										
203188 (ROSG 16/I-506)					2	-										
203189 (ROSG 16/I-506/S)			1	2		-										2
203190 (ROSG 16/x-506)						2										-
203191 (ROSG 16/x-506/S)						-										2

RDF - Menovitý súčiniteľ súdobosti, InA - Menovitý prúd zostavy

so 63 A zásuvkou, vypínačom, prívodkou a možnosťou slučkovania

Obj. č. (Typ)	Osadenie	CEE 400 V 5P			250 V		Hlavný vypínač 63 A	Prúdové chrániče RCCB 63 A/4/0,03 A	Ističe MCB			Pripojenie	Krytie	InA	RDF	Bal. (ks)
		63 A	32 A	16 A	16 A Fr	16 A Sch			32 A 3P-C	16 A 3P-C	16 A 1P-B					
203200 (ROS 16/FI-603)					4	-	1	1	1	4	CEE prívodka 63 A/5P/400 V	IP54	InA 63 A	0,5	1	
203201 (ROS 16/FI-603/S)					-	4										
203202 (ROS 16/I-603)					4	-										
203203 (ROS 16/I-603/S)			1	1	1	-										4
203204 (ROS 16/x-603)						4										-
203205 (ROS 16/x-603/S)						-										4

RDF - Menovitý súčiniteľ súdobosti, InA - Menovitý prúd zostavy